

# HANDLEBAR MOUNTING-SET

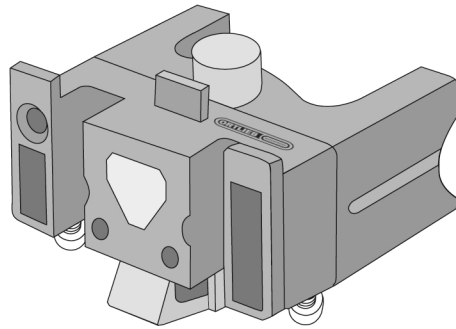

- DE MONTAGEANLEITUNG:
- GB ASSEMBLY INSTRUCTIONS:
- FR INSTRUCTIONS DE MONTAGE:
- IT ISTRUZIONI DI MONTAGGIO:
- NL MONTAGE HANDLEIDING:
- DK MONTERINGSVEJLEDNING:
- ES INSTRUCCIONES DE MONTAJE:
- SE MONTERINGSANVISNING:
- NO MONTERINGSANVISNING:
- FI ASENNUSOHJEET:
- PL INSTRUKCJA MONTAZU:
- JP 装着方法

## HANDLEBAR MOUNTING-SET



Art. # E225

## HANDLEBAR MOUNTING-SET WITH LOCK

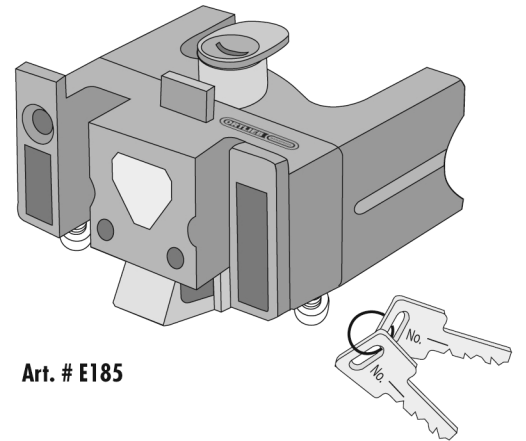

Art. # E185

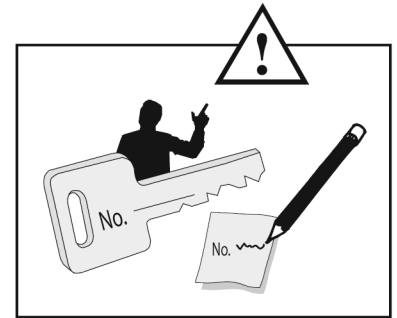
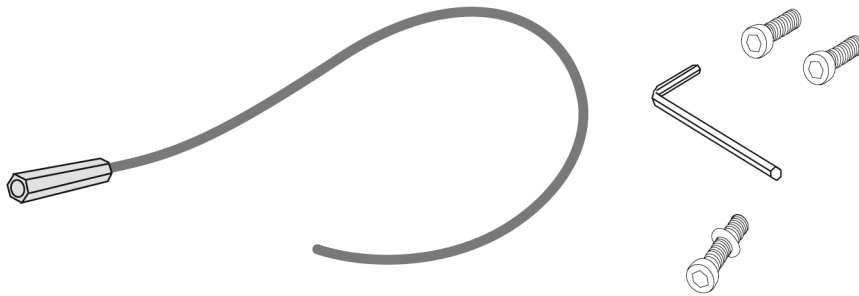

1.

22 - 31,8 mm  
(Small to oversized) ✓ = O.K.

2.

Carbon ✗

3.

✓ = O.K.

4.

1x ⌚  
= #4

5.

✓ = O.K.

6.

Pull

✓ = O.K.

7.

1,0 Nm = #4

8.

90°  
✓ = O.K.

9.

0,5 Nm  
1,0 Nm  
= #4 = #4

10.

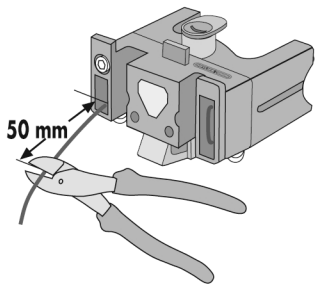

11.

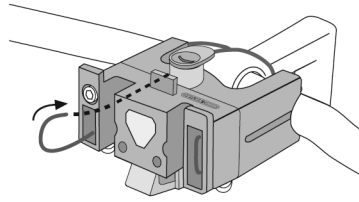

12.

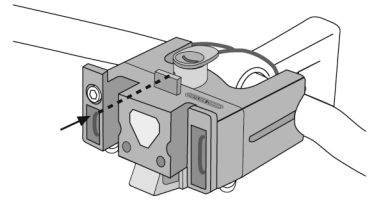

13.

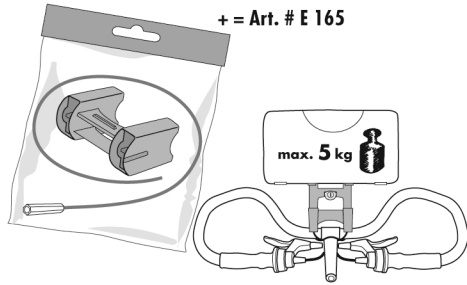

14.

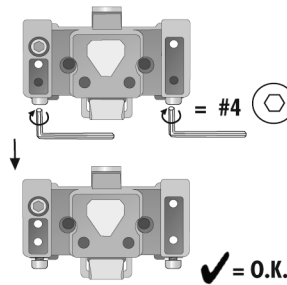

15.

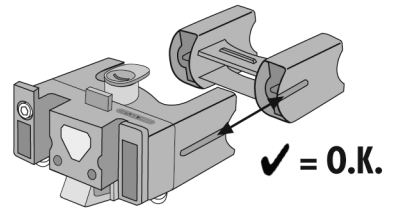

16.

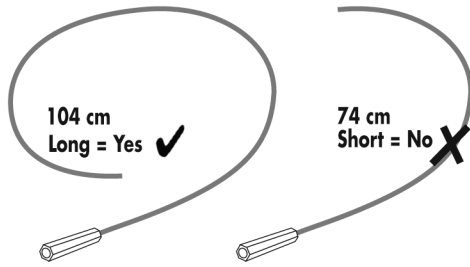

17.

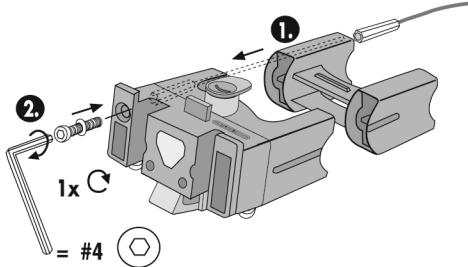

18.

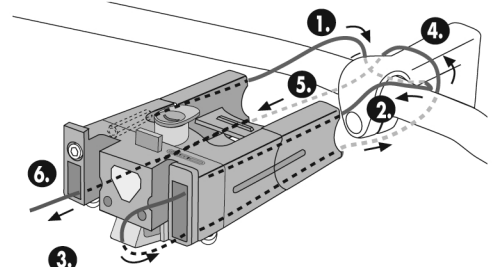

19.

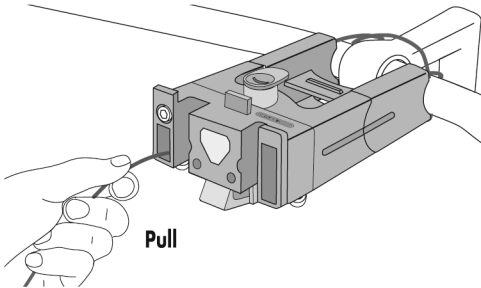

20.

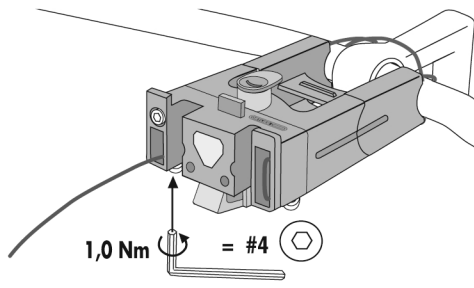

21.

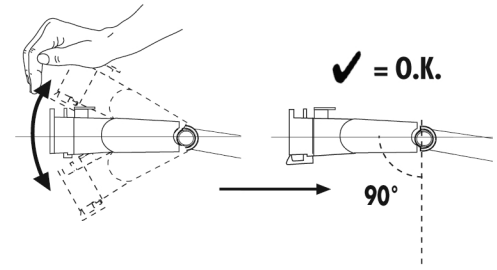

22.

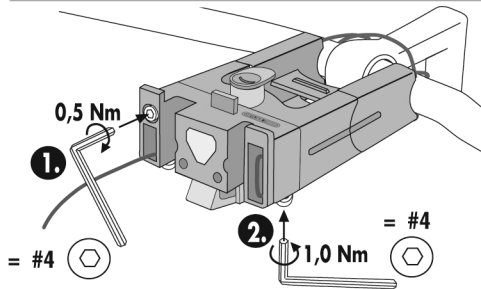

23.

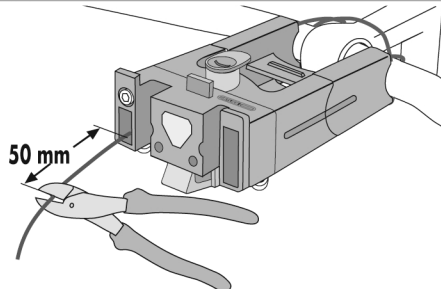

24.

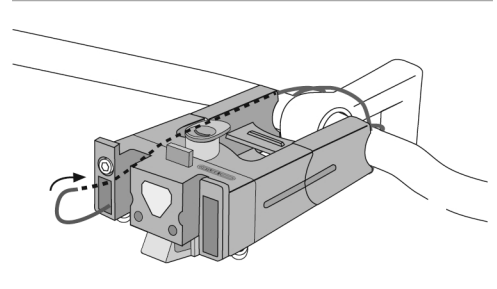

25.

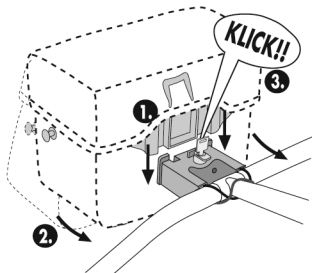

26.

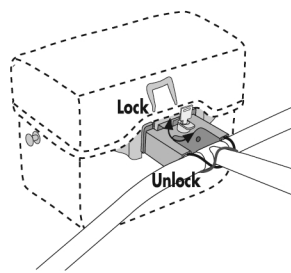

27.

